









COOKING CENTRES

IOC9SE3



Colour:	Stainless Steel
Model:	IOC9SE3 Multifunction Programmable Oven 900mm
Dimensions:	875 to 930mm (H) x 900mm (W) x 600mm (D)
Cutout Dimensions:	910mm (H) X 910mm (W) X 600mm (D) 5mm space required either side of the appliance
OVEN Functions:	<ul style="list-style-type: none">  Oven off  Oven light on, which stays on for all functions  Defrost  Top and bottom heating elements  Top and bottom heating elements and fan  Bottom heating element and fan  Fan forced heating element and fan  Grill heating element  Grill heating element and fan
Features:	<ul style="list-style-type: none"> • Easy to clean "acid resistant" enamel • Double glazed door, removable inner glass for easy cleaning • Fully programmable timer with digital clock display • Removable door • Storage area located under oven • 5 Shelf positions
Oven Capacity:	110 Litres
Safety:	<ul style="list-style-type: none"> • Auto Safety Switch Off • Anti-tilt hook and safety chain (must be fitted to wall to rear of cooker)
Temperature Selection:	50° Celsius to Maxi
TRAY CONFIGURATION	
Oven:	2 x Chrome Oven Grids 1 x Grill Pan 1 x Baking Pan 1 x Grill Pan Handle
Hob:	3 X Cast iron trivets with rubber corner feet 1 X Wok Pan Support
Power Requirements:	220 - 240 volt / 50Hz
Kilowatt Rating:	3.2kW, minimum 15 amp connection
Total Gas Input:	NG - 43.4Mj / LPG - 42.8Mj
Country of Origin:	Italy

COOKING CENTRES

IOC9SE3

GAS COOKTOP

Burners	Gas	Diameter Injectors	Operating Pressure (kPa)	Burner Rating (MJ)	Pan Diameter (CM)
Front left (Rapid)	Propane (LPG)	0.88	2.75	10.0	20-22
	Natural (NG)	1.42	1.00	10.0	
Rear Right (Semi-rapid)	Propane (LPG)	0.73	2.75	7.2	16-18
	Natural (NG)	1.20	1.00	7.2	
Rear left (Semi-rapid)	Propane (LPG)	0.73	2.75	7.2	16-18
	Natural (NG)	1.20	1.00	7.2	
Front right (Auxillary)	Propane (LPG)	0.54	2.75	3.8	12-14
	Natural (NG)	0.90	1.00	4.0	
Centre (WOK)	Propane (LPG)	1.02	2.75	14.6	22-24
	Natural (NG)	1.75	1.00	15.0	

Other:

- Suitable for natural gas and LPG - LPG jets supplied with appliance
- AGA approved
- Gas entry point at top rear right hand side of appliance
- Electrical connection at rear left hand side of appliance
- Automatic under knob ignition

COOKING CENTRE DIMENSIONS

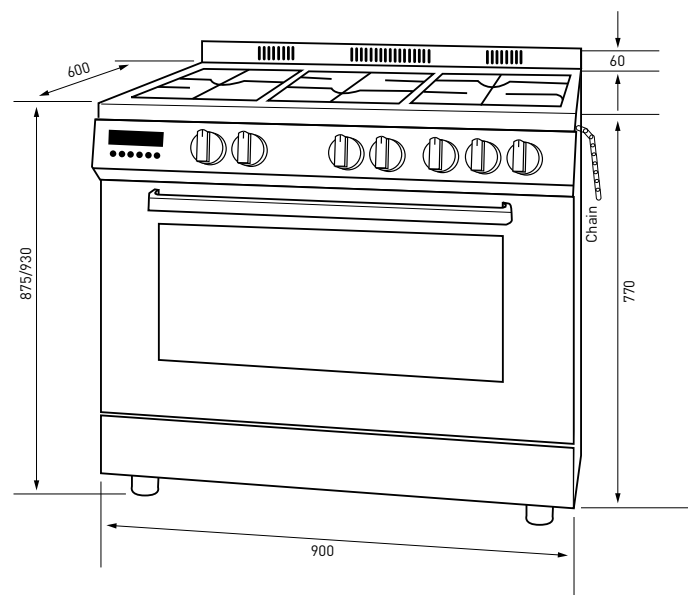

INSTALLATION INFORMATION

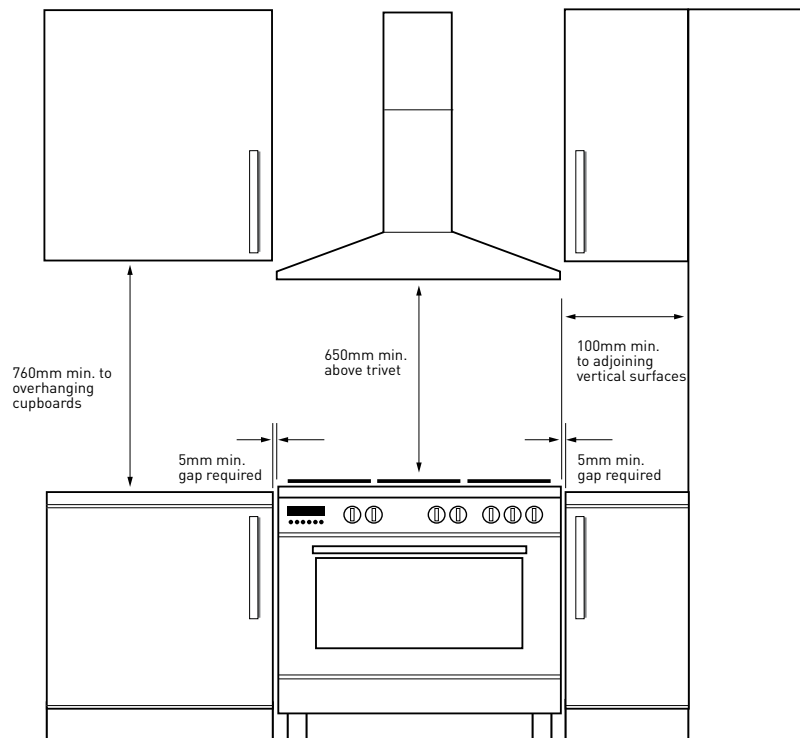

The above requirements must be adhered to. Failure to do so may lead voiding of warranty.

The IOC9SE3 can be built-in into the surrounding cupboards by removing the legs from the base of the cooker and placed onto a plinth. In doing so there **MUST** be a cut out in the plinth to ensure proper ventilation to the cooking centre. This cutout should measure 700mm wide x 400mm deep. The plinth or supports for the cooking centre must be able to withstand the weight of the appliance.

All IAG Appliances have a complete 2-Year Warranty on parts and labour. Our Toll Free Customer Service Number 1800 805 300 provides helpful advice and ready access to a nationwide service team.



EXTENDED WARRANTY

All IAG electric or gas appliances for your kitchen are now available with an OPTIONAL full 5 year Parts and Labour Warranty. Visit www.iagappliances.com.au or call our Toll Free Customer Service Number 1800 805 300 for details.