

RANGEHOODS

SLIDE OUT RANGEHOOD 900



Colour:	Stainless Steel						
Model:	IR09SE2						
Dimensions:	175mm (H) x 898mm (W) x 298mm (D) Note the height of 175mm includes the handle height of 40mm giving an internal height of 135mm						
Packaging:	<table border="0"> <tr> <td>Carton Size</td> <td>94 cm (H) x 37 cm (W) x 21 cm (D)</td> </tr> <tr> <td>Carton Cubic metres</td> <td>0.073 cubic metres</td> </tr> <tr> <td>Carton Weight</td> <td>13 kg</td> </tr> </table>	Carton Size	94 cm (H) x 37 cm (W) x 21 cm (D)	Carton Cubic metres	0.073 cubic metres	Carton Weight	13 kg
Carton Size	94 cm (H) x 37 cm (W) x 21 cm (D)						
Carton Cubic metres	0.073 cubic metres						
Carton Weight	13 kg						
Motor:	Twin (140 watts each)						
Airflow:	Airflow = max. 400m ³ /h						
Sound Level:	Max. 59 dBA						
Controls:	2 speed, operated manually by separate switch on right hand side.						
Lamps:	2 x 40 W, lights operated manually by separate switch on right hand side of unit.						
Grease Filter:	Aluminium mesh						
Ducting:	Top Only (for details refer to Ducting Specification Sheets under accessories on the website) also see following page for ducting methods applicable.*						
Duct Spigot:	120 mm						
Re-circulating:	Only through to top of cupboard or through a bulkhead. In re-circulation ducting is required and fitted between the ducting spigot and top of cupboard or through the bulkhead. A mesh cover is recommended to keep out rodent or insects.						
Carbon Filters:	Code IXCF3 (2 required) – available for purchase on 1800 805 300.						
Minimum Height Above Cooktop:	Gas: 650mm Electric: 600mm						
Method of Installation:	Built into overhead cupboard						
Power Requirement:	240V 10 Amps						
Note:	298mm depth is the minimum cabinet depth required for rangehood. Allow a min. of 10mm extra if wall is tiled before fitting rangehood.						
Country of Origin:	Italy						

* Ducting supplied by installer

RANGEHOOD DIMENSIONS

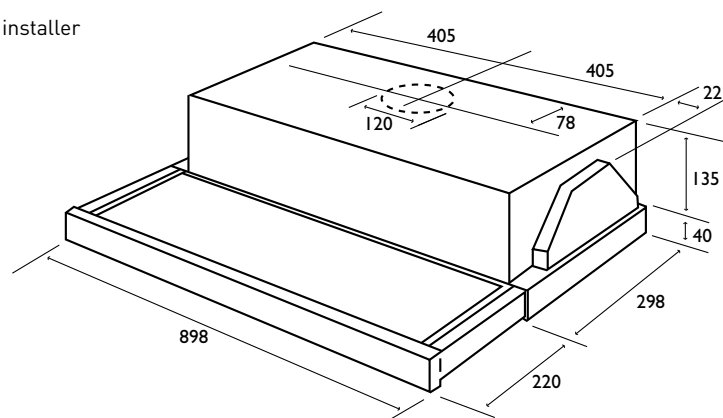

www.arcappliances.com.au

RANGEHOODS

SLIDE OUT
RANGEHOOD
900

**DUCTING & RE-CIRCULATING INSTALLATION OPTIONS FOR
SLIDEOUT RANGEHOODS**

Rear ducted to outside

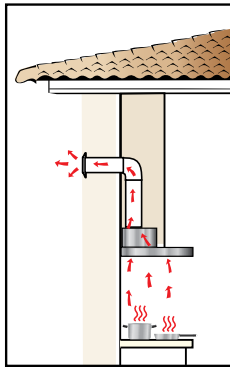

Top ducted to outside

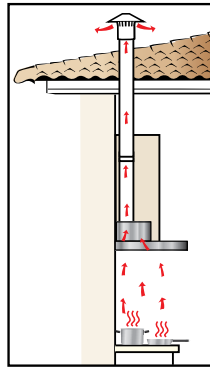

Side ducted to outside

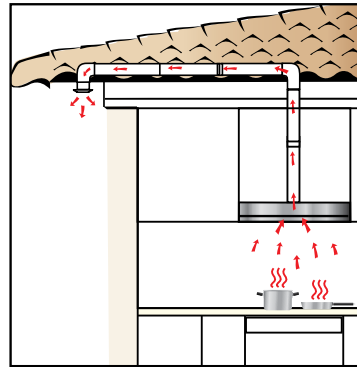

Side ducted through bulkhead

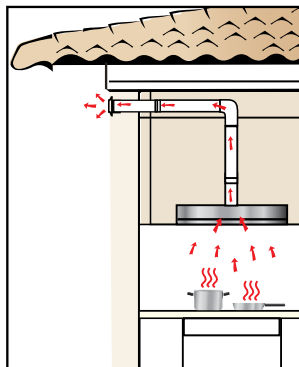

Top re-circulating through cupboard

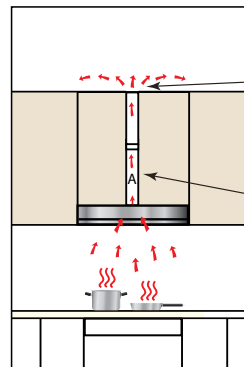

Top re-circulating through bulkhead

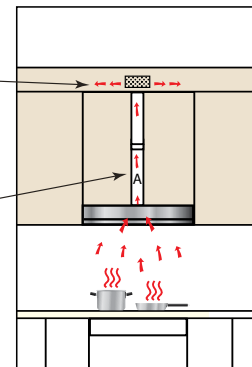

All ARC Appliances have a complete 2-Year Warranty on parts and labour. Our Toll Free Customer Service Number 1800 805 300 provides helpful advice and ready access to a nationwide service team.



EXTENDED WARRANTY

All ARC electric or gas appliances for your kitchen are now available with an OPTIONAL full 5 year Parts and Labour Warranty. Visit www.arcappliances.com.au or call our Toll Free Customer Service Number 1800 805 300 for details.